

Optical Interleavers

Optoplex's **Optical Interleaver** products are based on our patented *Step-Phase Interferometer* design. Used as a DeMux (or Mux) device, an optical interleaver separates (or combines) the Even and Odd channel signals (see the schematic diagrams in Figure 1 below). Each optical interleaver device is optimized to cover either C- or L-band wavelengths, with the option of covering C+L band. The current optical interleaver product family supports 100-200, 50-100, 25-50 GHz, and other custom channel spacings. The DeMux and Mux interleavers can be effectively co-packaged into a single box for easy handling and cost-saving. Dual-stage optical interleavers (such as 25-100 GHz channel spacing) and asymmetric interleavers (Even and Odd channels have different passband bandwidths) are also available.

Key Features and Benefits

- Wide and flat passband
- Minimal PDL
- High channel isolation
- Minimal thermal drift
- Low and customizable dispersion
- Low insertion loss & IL uniformity
- Dual C- and L-band coverage
- DeMux/Mux co-packaged solution available
- Asymmetric/uneven optical interleaver available

Applications

- Extend existing network capacity
- Bridge existing & new DWDM platforms
- System upgrade
- Bi-directional networks
- Total signal power detection for Raman amplifier
- Multi-wavelength transponder
- Flat-top comb filter

Optical De-Interleaver

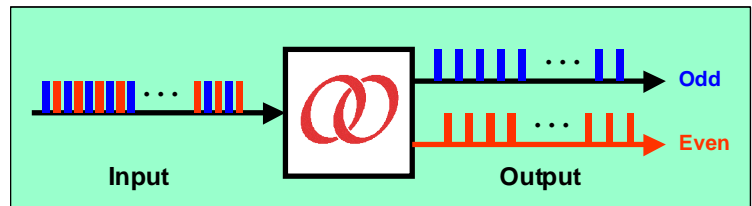

Optical Interleaver

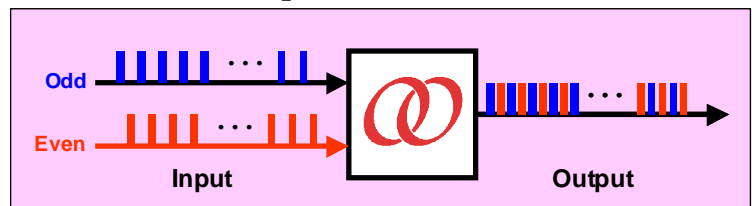

Figure 1 - Schematic diagrams of optical de-interleaver and interleaver.

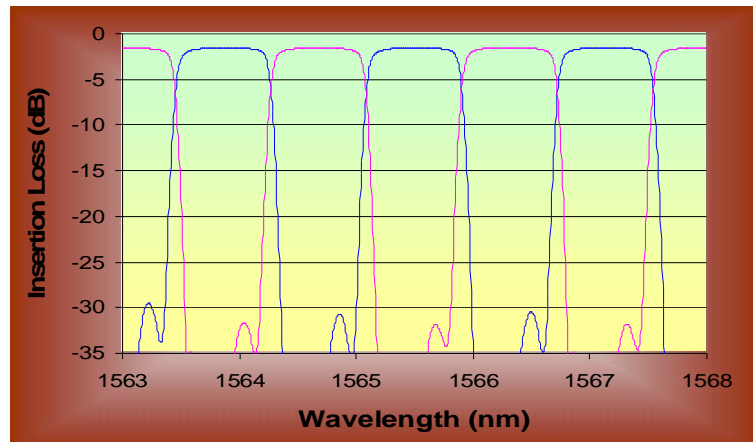

Figure 2 - Measured Spectral Profiles of a 100/200GHz interleaver.

Optoplex's Advantages

Small Channel Spacing

Optoplex has special expertise in designing and manufacturing high performance optical interleavers with small channel spacing.

Besides the standard 50/100 and 100/200 GHz interleavers for DWDM applications, Optoplex started volume production of 33.33/66.67 and 25/50 GHz interleavers for subsea optical networking applications. With smaller channel spacing, more channels can be populated into a fiber to increase transmission capacity.

Today, Optoplex also supplies 37.5/75 and 40/80 GHz interleavers for flex-grid and super channel applications.

In addition, Optoplex also provides solutions for smaller channel spacing interleavers, such as 12.5/25 and 6.25/12.5 GHz.

Custom design is available. Contact Optoplex at sales@optoplex.com for details.

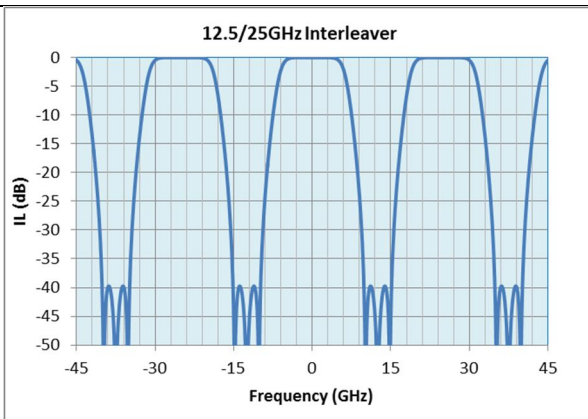

Figure 3 - Designed Spectral Profile of 12.5/25GHz Interleaver.

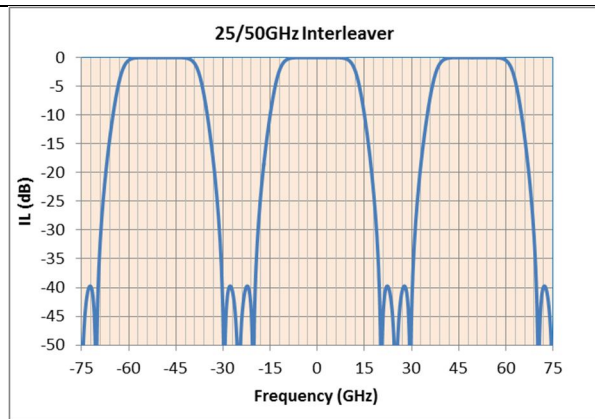

Figure 4 - Designed Spectral Profile of 25/50GHz Interleaver.

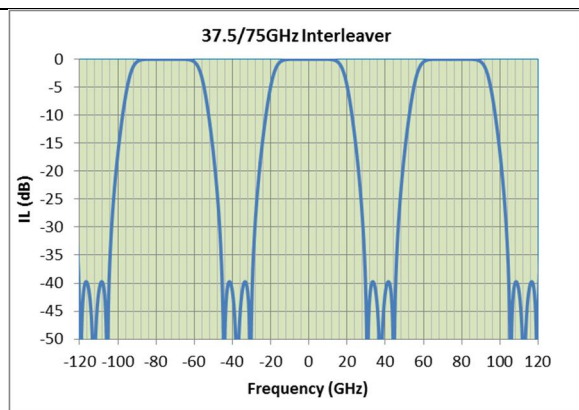

Figure 5 - Designed Spectral Profile of 37.5/75GHz Interleaver.

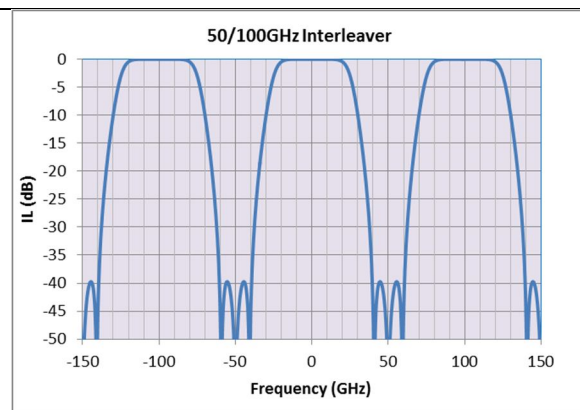

Figure 6 - Designed Spectral Profile of 50/100GHz Interleaver.

Asymmetric Design

Usually, an optical interleaver offers symmetric optical spectral profiles for both odd- and even-output ports (except for the frequency off-set applied on one port with respect to the other).

Optoplex is able to design "asymmetric interleaver" from which the odd and even output spectra is asymmetric, for instance, 70% bandwidth for the odd channel and 30% for the even channel. The ratio can be custom designed to satisfy your demanding applications.

Normally, the signal spectral profiles (bandwidths) are different for signals of different data rates. For instance, 100Gbps signal's spectrum is wider than 40Gbps', and 40Gbps' is wider than 10Gbps'.

With Optoplex's Asymmetric Interleavers, one can easily Mux different data rates' signals together, or oppositely DeMux different data rates' signals.

Asymmetric interleaver can be made for any channel spacing.

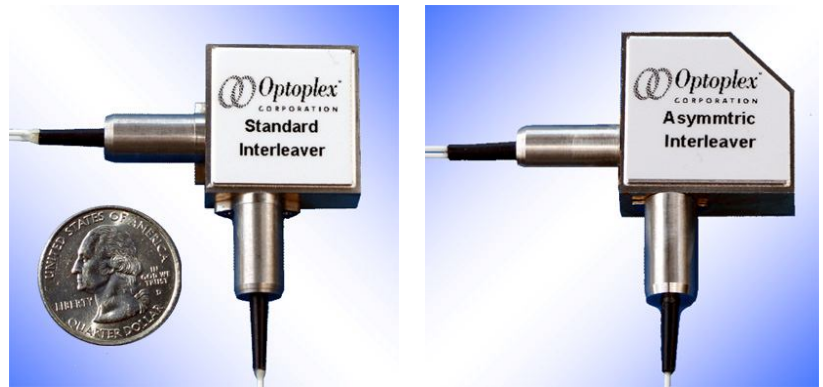

Symmetric Interleaver

Asymmetric Interleaver

Figure 7 - Stand-alone Standard and Asymmetric Interleavers.

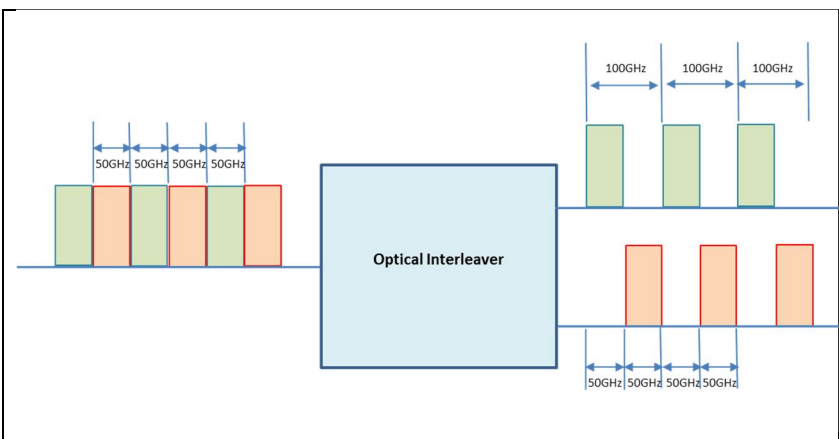

Figure 8 - Symmetric Interleaver Illustration.

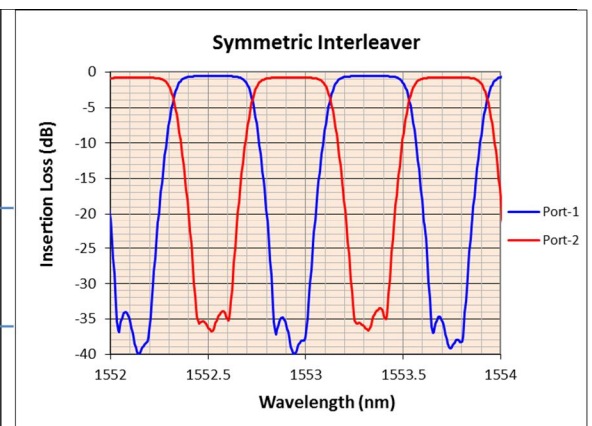

Figure 9 - Measured output spectra of a symmetric 50/100GHz interleaver.

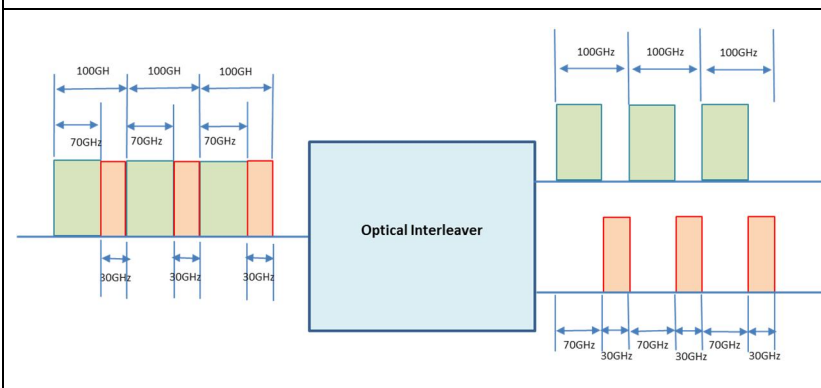

Figure 10 - Asymmetric Interleaver Illustration.

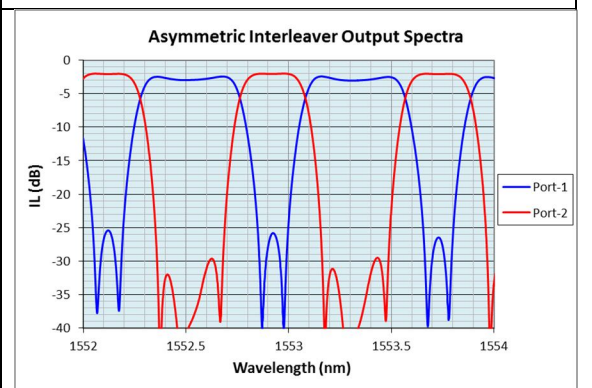

Figure 11 - Measured output spectra of an asymmetric interleaver.



Super-Wide Passband Interleaver

By nature, Optoplex's optical interleaver has much wider bandwidth than the same of interleavers built by other technologies. For instance, the 0.5dB bandwidth of Optoplex's standard 50/100GHz interleaver is about 30GHz (CCF +/-15GHz, CCF = channel center frequency), while, the 3dB BW of interleavers built by other technologies is about 20GHz (CCF +/-10GHz).

On top of that, Optoplex has developed and launched a "super"-wide passband interleaver (called "super interleaver") that offers even wider bandwidth. For example, the 3dB bandwidth of 50/100GHz "super" interleaver is larger than 40GHz. Moreover, the "super" interleaver offers much wider stop-band bandwidth, more than 35GHz (at -25dB), comparing to about 20GHz by competitive technologies'.

Optoplex's super interleaver is an ideal optical component in 100Gbps and 400Gbps applications. It improves the spectral power efficiency and OSNR performance in super-channel and high data rate transmission where the signal spectrum is wider.

The "super"-wide passband interleaver can be applied to the design of any channel spacing optical interleaver, from 12.5GHz to 200GHz. Contact Optoplex at sales@optoplex.com for more details.

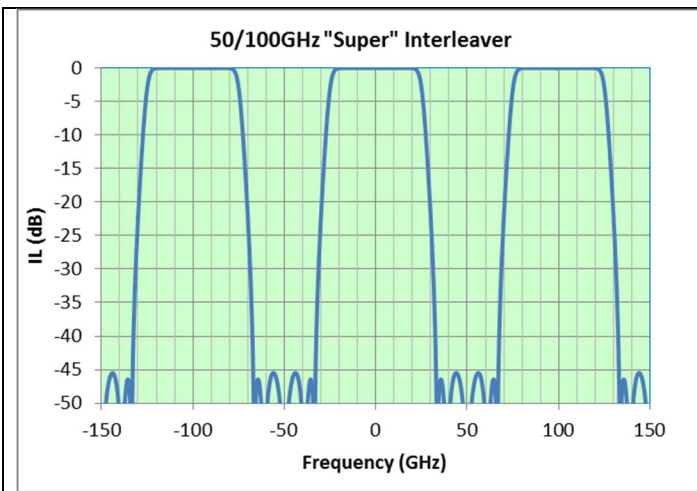

Figure 12 - "Super"-Wide Passband Interleaver.

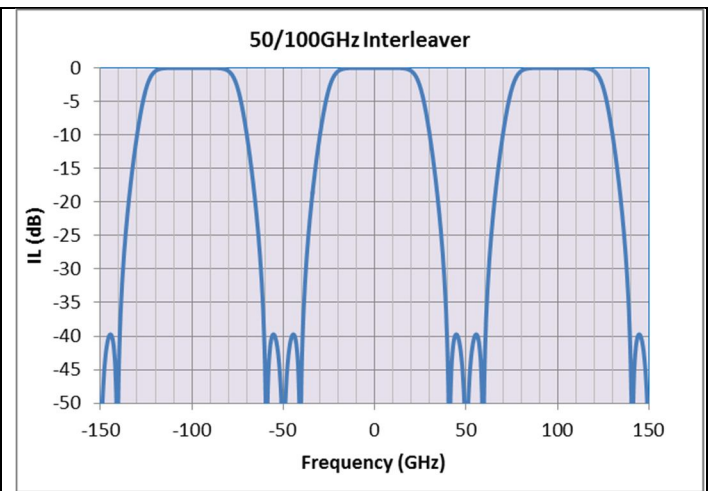

Figure 13 - Standard Interleaver.

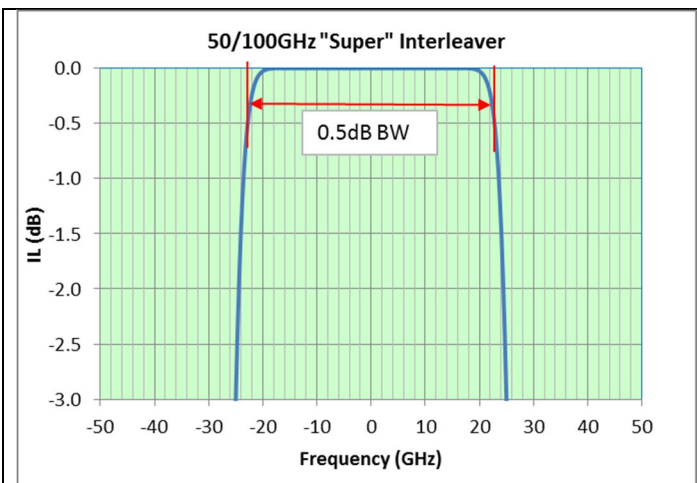

Figure 14 - 0.5dB BW of "Super"-Wide Passband Interleaver.

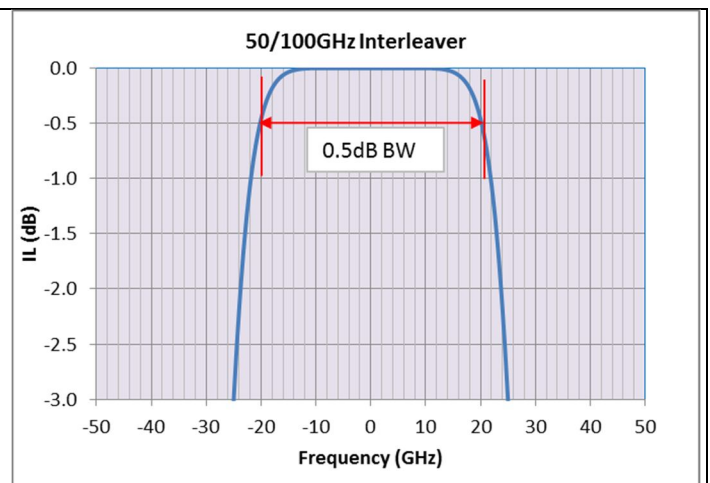

Figure 15 - 0.5dB BW of Standard Interleaver.

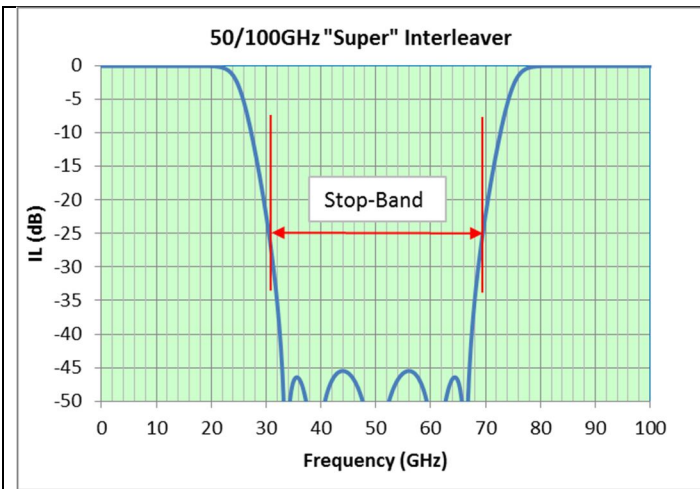

Figure 16 - Stop-Band of "Super"-Wide Passband Interleaver.

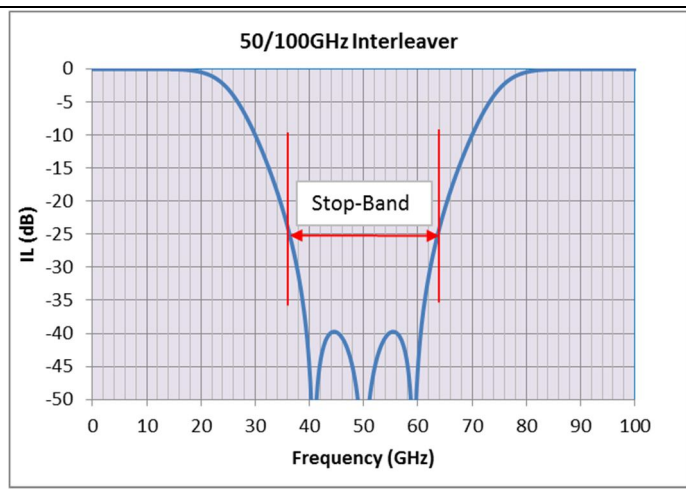

Figure 17 - Stop-Band of Standard Interleaver.

Low-Chromatic Dispersion Design

Normally, the chromatic dispersion in the pass-band (@-0.5dB) of a 50/100GHz interleaver is about +/-200ps/nm (max). Optoplex developed a special design for low chromatic dispersion that is about +/-15ps/nm in a 50/100GHz interleaver. See below charts. Low chromatic dispersion is very important in high-speed long-haul transmission, especially in those non-coherent systems.

Low-CD design can be applied to any channel spacing interleaver, from 12.5/25GHz to 200/400GHz. Contact Optoplex at sales@optoplex.com for more details.

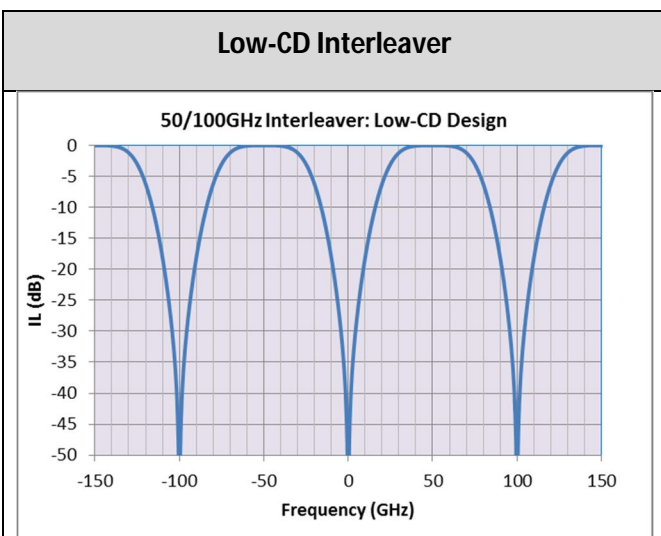

Figure 18 - Low-CD Interleaver.

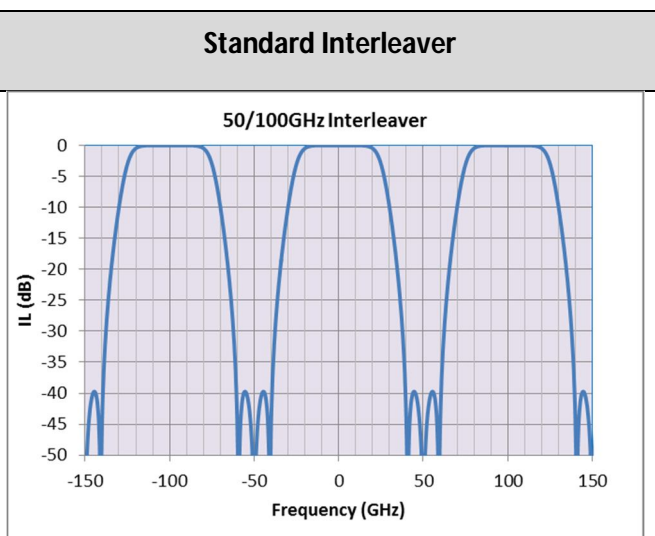

Figure 19 - Standard Interleaver.

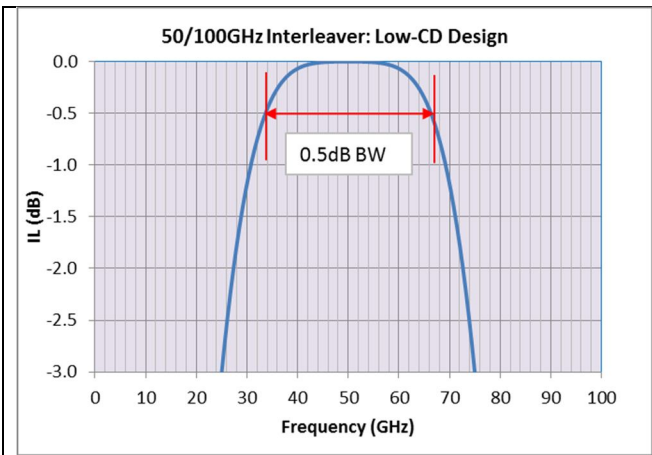

Figure 18 - 0.5dB BW of Low-CD Interleaver.

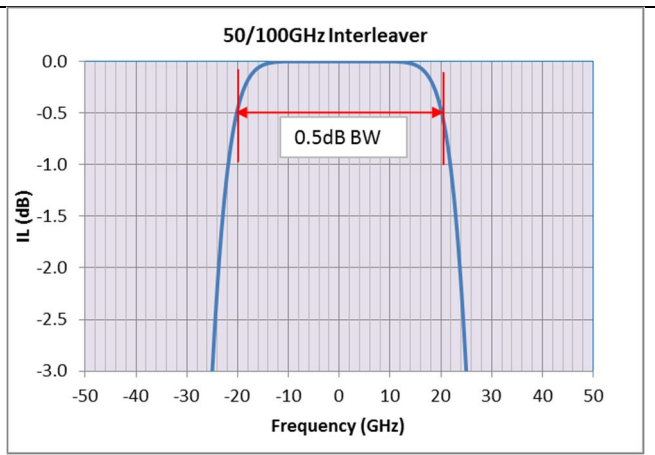

Figure 19 - 0.5dB BW of Standard Interleaver.

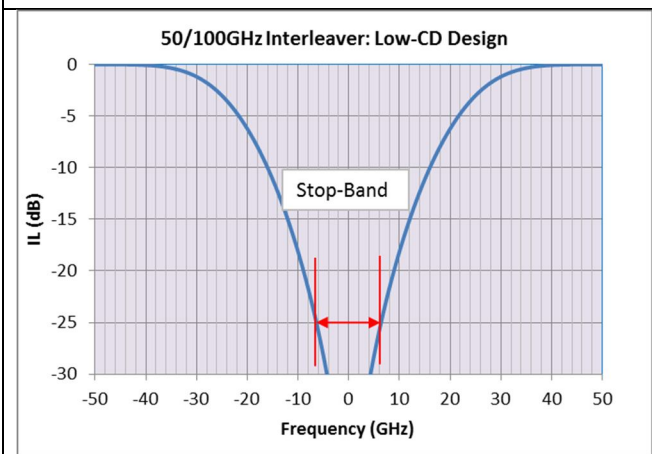

Figure 20 - Stop-Band of Low-CD Interleaver.

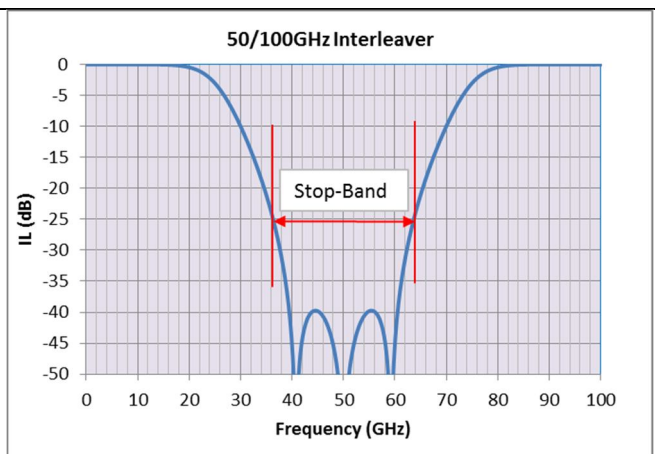

Figure 21 - Stop-Band of Standard Interleaver.

Low-CD Interleaver

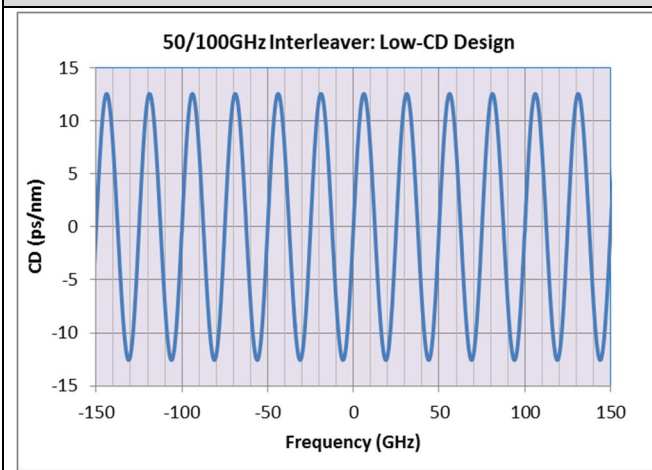

Figure 22 - CD Spectrum of Low-CD Interleaver.

Standard Interleaver

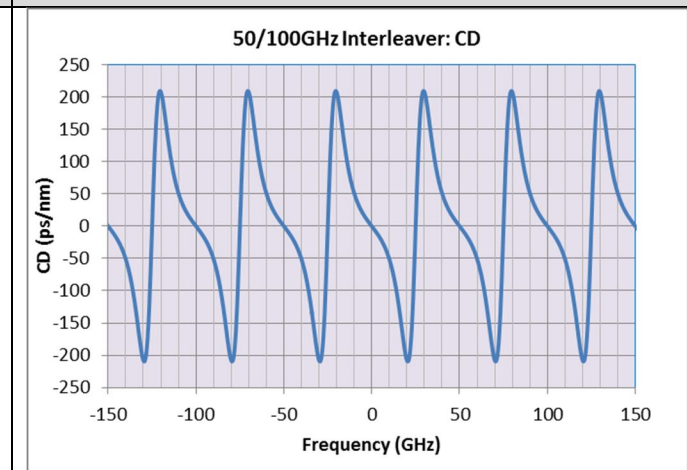

Figure 23 - CD Spectrum of Standard Interleaver.

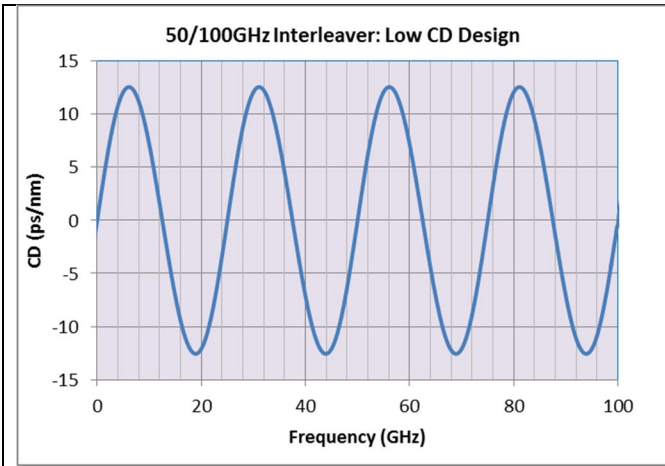

Figure 24 - Zoom-in CD Spectrum of Low-CD Interleaver.

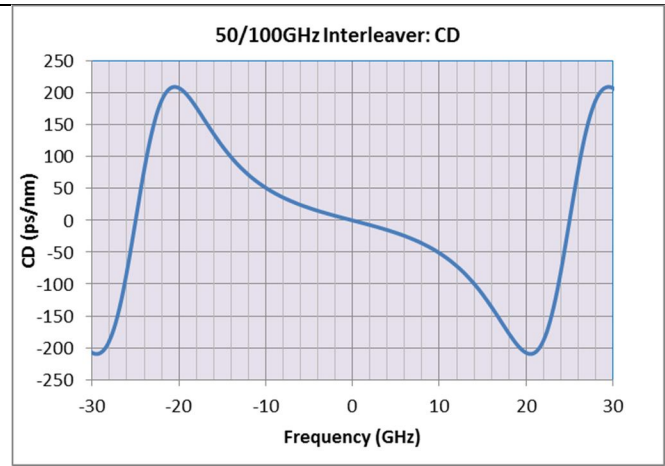

Figure 25 - Zoom-in CD Spectrum of Standard Interleaver.

Co-Packaged Solution



Optoplex has proprietary technology to design and manufacture “co-packaged” interleaver – that is a Mux and a DeMux interleavers share the same optics in a package with the same form factor as used in an individual interleaver. Compare to discrete (using two individual interleavers, one as a Mux and another one as a DeMux) approach, Optoplex’s Co-Packaged solution offers below:

Features & Benefits

- Save 50% space (compared to that of individual solution where a separate Mux and DeMux are used)
- At least 30% of cost-saving than the individual solution
- Same performance (as individual approach)
- Same reliability (as individual approach)
- Proven track records

Single-Stage Co-Packaged Solution

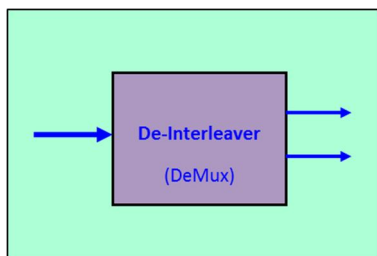

Figure 26 - Interleaver DeMux.

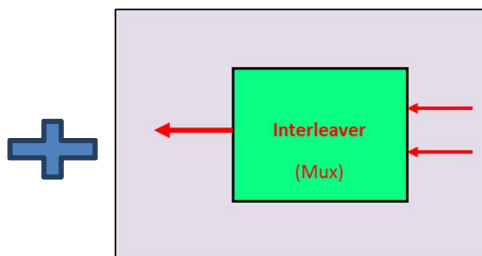

Figure 27 - Interleaver Mux.

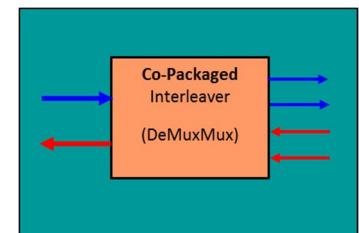

Figure 28 - Co-Packaged Interleaver (Mux/DeMux).

Two-Stage Co-Packaged Solution

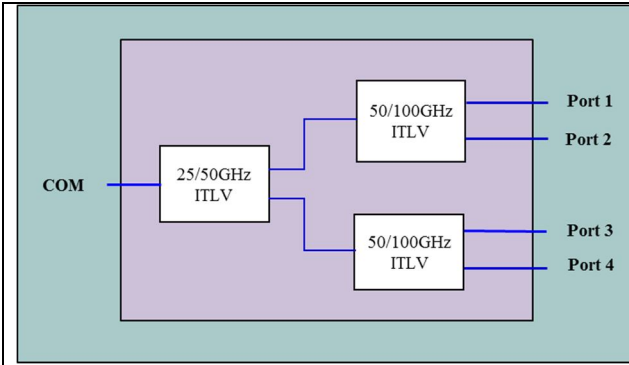

Figure 29 - A standard two-stage 50/200GHz Interleaver.

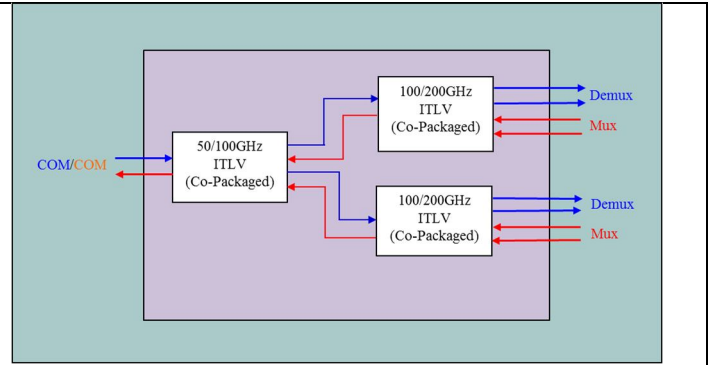

Figure 30 - A Mux/DeMux Co-Packaged 50/200GHz Interleaver.



Figure 31 - 25/50GHz Mux/DeMux Co-Packaged Interleaver Module.



Figure 32 - 50/100GHz Mux/DeMux Co-Packaged Interleaver Module.



Figure 33 - 50/200GHz Two-Stage Mux/DeMux Co-Packaged Interleaver Module.

Multiple-Staged Interleaver

Multiple-stage interleaver solutions are available. The configurations include:

<ul style="list-style-type: none"> ● Two-Stages: <ul style="list-style-type: none"> ○ 25/100GHz ○ 33.3/133.34GHz ○ 50/200GHz ○ 100/400GHz ○ Other customer specific 	<ul style="list-style-type: none"> ● Three-Stages: <ul style="list-style-type: none"> ○ 25/200GHz ○ 37.5/300GHz ○ 50/400GHz ○ Other customer specific
---	--

Options

- Mux/DeMux co-packaged solution
- "Super"-wide passband design
- Low-CD design

Contact Optoplex at sales@optoplex.com for details.

Switchable Interleaver

Optoplex developed a special interleaver, called "hitless switchable interleaver". It operates in two modes: At Mode-1, all input signals (from Port-A) go through directly to Port-B (all channels); At Mode-2, it functions like a regular interleaver – even channels output at Port-B while odd channels output at Port-C. During the change of operation mode, there is no hit to the output – it is "hitless".

The hitless switchable interleaver can be designed for any channel spacing from 12.5/25GHz to 200/400GHz.

If you have any special requirement for such switchable interleaver, please contact Optoplex at sales@optoplex.com.

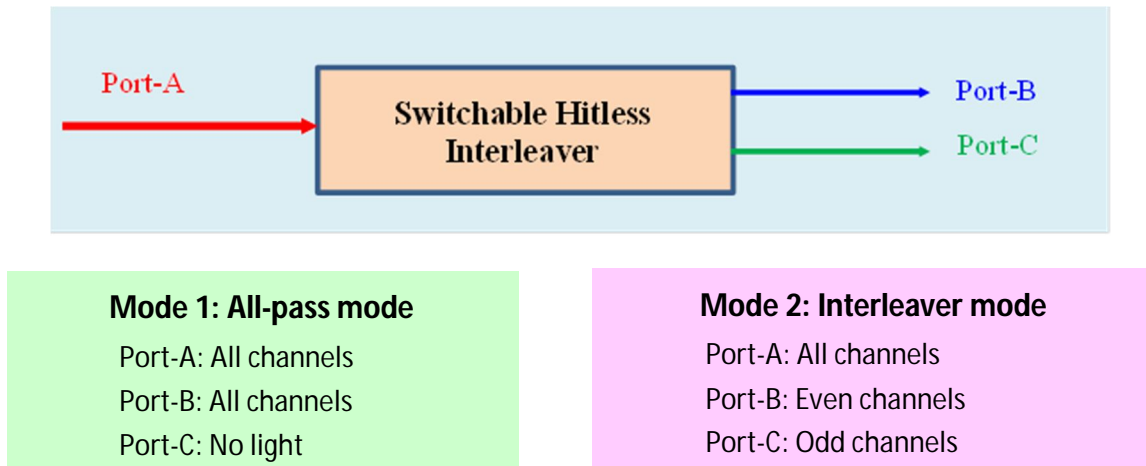

During mode switching, Even-Channels (Port-B) are not affected — Hitless!

Figure 34 - Schematic Diagram and Functionality of Switchable Hitless Interleaver.

Custom Design

- **Spectral Profile**

Optoplex has expertise in designing and manufacturing customer-specific interleavers to satisfy your demanding applications. Besides the channel spacing (or FSR), we can tailor the design to achieve special optical performance such as bandwidth, isolation, and chromatic dispersion, etc. Of course, the asymmetric interleaver is also available.

- **Functionalities**

Co-packaged design is to have both Mux and DeMux functions equipped in a package with a form factor the same as an individual interleaver (only functions as a Mux or a DeMux).

Multiple-stage configuration is available. Again, co-packaged solution can be applied to multi-stage interleaver to save dramatic space and the cost.

- **Integration**

Optoplex can also integrate other optical components with optical interleavers, such as optical couplers/splitters, Taps and Photo-diodes, OSC filter, Red/Blue filters, and/or other DWDM filters.

In a complex system, such as multiple-stage interleavers integrated with couplers, PDs and filters, Optoplex's co-packaged solution has benefits over other competitive technologies' since it takes much less space and it is much cost-effective.

Contact Optoplex at sales@optoplex.com for the best solution to satisfy your needs.

Product Specification: Standard Interleaver (C-, L-, or C+L band, Bi-directional, Regular-design (except Low CD)), R1.0; 12-30-15

Parameter	Unit	25-50 GHz	33.33-66.67 GHz	37.5-75 GHz	50-100 GHz Low CD	50-100 GHz High CD	100-200 GHz	200-400 GHz
Wavelength Range	nm	1527 ~ 1567 for C-band, 1567 ~ 1607 for L-band, or 1527 ~ 1607 for C+L band						
Channel Center Alignment	-	ITU Grid						
Insertion Loss ¹ (without connector)	dB	<2			<2.6	<1.8		
Insertion Loss Uniformity ¹ (over all channels)	dB	<0.5				<0.4		
Passband Width ¹ @0.5dB	GHz	>ITU±7	>ITU±9	>ITU±11	>ITU±15	>ITU±15	>ITU±30	>ITU±50
Channel Isolation ¹	dB	>20 over ITU±5 GHz	>21 over ITU±7 GHz	>22 over ITU±7.5 GHz	>24 over ITU±8 GHz	>24 over ITU±8 GHz	>24 over ITU±16 GHz	>24 over ITU±30 GHz
Passband Ripple ¹ (within 0.5dB passband)	dB	<0.5	<0.4	<0.3		<0.2		
PDL ¹ (within 0.5dB passband)	dB	<0.3				<0.2		
Chromatic Dispersion ¹	ps/nm	<±320 over ITU±5 GHz	<±200 over ITU±7 GHz	<±140 over ITU±7.5 GHz	<±35 over ITU±10 GHz	<±75 over ITU±10 GHz	<±20 over ITU±16 GHz	<±10 over ITU±30 GHz
PMD ¹ (within 0.5dB passband)	ps	<0.2						
Return Loss	dB	>40						
Directivity	dB	>45						
Max Input Power	mW	300						
Operating Temperature	°C	0 ~ 65						
Storage Temperature	°C	- 40 ~ 85						
Dimension (L x W x H)	mm	122 x 70 x 14						
Pigtail Type	-	SMF-28 or equivalent with 900µm tight buffer						
Connector Type	-	FC, LC, SC, MU, or no Connector						
Pigtail Length	m	1.0±0.1						

1. Over the stated spectral and operating temperature ranges and all polarization states.

Ordering Information

Part Number Assignment for Standard Interleavers

(Examples below are for C-band, Regular design (except Low CD), and FC/UPC connector.)

See below for P/N rules. Contact Optoplex should you have any question or what you need are not among below list.

Channel Center Frequency (CCF) Alignment	on ITU Grid	with ITU+50GHz	with ITU+25GHz	with ITU-25GHz	with ITU+12.5GHz
25-50 GHz	IL-C0RBFCS002	NA	NA	NA	IL-C0RBFCS004
33.33-66.67 GHz	IL-CTRBFCS002	NA	NA	NA	NA
37.5-75 GHz	IL-CBRBFCS001	NA	NA	NA	IL-CBRBFCS002
50-100 GHz Low CD	IL-C1LBFCS001	NA	IL-C1LBFCS005	IL-C1LBFCS009	IL-C1LBFCS010
50-100 GHz High CD	IL-C1RBFCS002	NA	IL-C1RBFCS007	IL-C1RBFCS011	IL-C1RBFCS012
100-200 GHz	IL-C2RBFCS001	IL-C2RBFCS002	IL-C2RBFCS005	IL-C2RBFCS006	IL-C2RBFCS009
200-400 GHz (Even)	IL-C3RBFCS001	IL-C3RBFCS005	IL-C3RBFCS009	IL-C3RBFCS011	IL-C3RBFCS017
200-400 GHz (Odd)	IL-C3RBFCS003	IL-C3RBFCS007	IL-C3RBFCS013	IL-C3RBFCS015	IL-C3RBFCS018

Interleaver P/N Rules

